





## Vega™/Capella™ Installation Instructions

(Part #'s 200 or 300 Series Lights)

<b>PARTS INCLUDED:</b>			
			
Linear LED Task Light	Male/Male Connector - 690020.008	Female/Female Switch - 690020.006	UL Recognized Power Supply*
			<b>TOOLS NEEDED:</b>
			
Wire Management Clip - U1B5NZM	Striker Plates (Capella light only)	Phillips Screwdriver (installation into non-metal substrates)	

### Vega/Capella Hardwire Safety Instructions

**IMPORTANT SAFETY INSTRUCTIONS. READ CAREFULLY FOR YOUR PROTECTION AND SAVE ALL INSTRUCTIONS.**

\*This power supply must be installed according to the National Electrical Code and local building codes. Do not use with magnetic AC dimming power supplies.

\*To avoid a hazard to children, account for all parts and destroy all packing materials.

\*If you are unsure about the installation or use of this power supply, consult a qualified electrician.

**\*CAUTION:** To reduce the risk of fire and electrical shock, use only fixtures intended for use with power supply designed for use with elio LED light.

\*Do not use wet locations.

\*Do not install any luminaire assembly closer than 6" from any curtain or other combustible material.

**LOW VOLTAGE CAUTIONS**

**APPLICATIONS**



Low voltage electronic power supplies should not be installed in areas with excessive heat around the power supply. Consult a qualified lighting designer if uncertain of the sustainability for a given application.

**SERVICE**

There are no user-serviceable parts inside. Opening unit will void warranty. Contact elio for service parts at 888-871-8860.

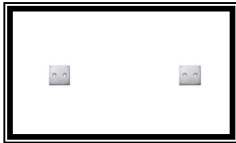
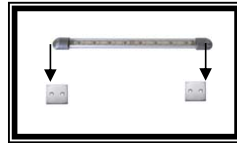
### LED Task Light Installation Instructions

<p><b>1.</b> Determine where your LED light fixture will be installed. In Pencil lightly outline where the end caps lie (<b>Note: If installing on a metal surface then proceed directly to Step 4).</b></p> <div style="text-align: center;">  </div>	<p><b>2. Capella Installation:</b> Center striker plates within pencil marks and screw the metal striker plates in place with screws. <b>Vega Installation:</b> Attach light by using screws provided and screwing into holes on either end cap.</p> <div style="text-align: center;">  </div>	<p><b>3.</b> Once the striker plates are in place, attach the LED task light's magnetic end caps to the metal striker plates.</p> <div style="text-align: center;">  </div>
---	---	--

<p><b>4.</b> Remove the end cap hole cap and insert male/male connector into LED light's female receptor.</p> 	<p><b>5.</b> Connect the female/female switch to the male/male connector.</p> 	<p><b>6.</b> Insert the male end of the 30 watt power supply to the open end of the female/female switch. Plug power supply into available electrical outlet.</p> 
---	---	---

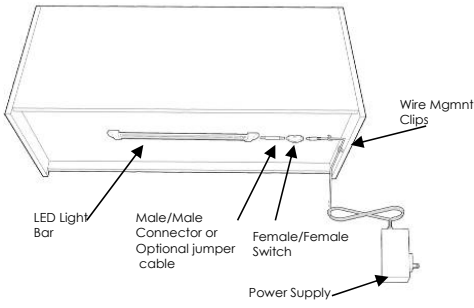
<p><b>7.</b> Use the wire management clips to adhere the power supply cord to the underside of the overhead</p> 	 <p><b>Figure 1</b> Vega/Capella Single Unit Installation</p>
---	---

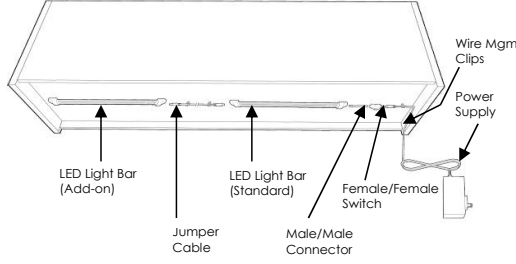
<p><b>8. Vega/Capella Add-On Installation:</b> Affix the add-on LED light in the desired location. Use the 30" jumper cable to connect the two LED lights by plugging one end of the jumper into the 1<sup>st</sup> LED light and the other end of the jumper into the other LED light. Remove cover caps as necessary to expose connector port.</p> 	 <p><b>Figure 2</b> Vega/Capella Add-on Installation Wiring Diagram</p>
--	--

**9. Troubleshooting**  
*If the light does not light:*

- Double check that the lines on the back of the light line up. If these lines do not line up, the end caps can be removed and switched to the other side. If your light does not have a line on the back, refer to the pictures below.

Line on light should align with line on end cap



Make sure the ridges on the end cap align with the ridges on the lens



Matches ridges on lens



Rounded end cap matches rounded portion on lens



- Make sure that the male connector is inserted all the way. This connection is a tight fit and may require a little bit of force to properly make the connection.
- Plug in the power supply from another working light to rule out of there is an issue with the light or power supply.
- Contact ITC/elio for replacement parts if the above steps do not resolve the problem.

For warranty information please visit [www.itc-us.com](http://www.itc-us.com)