





LOOK Backlit Mirror Install Instructions

Part #69455.ELS.XXXX.YYK & 69455.XXXX.YYK

PARTS/TOOLS NEEDED:

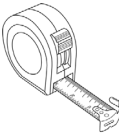
				
Backlit Mirror (Style varies)	Mounting Hardware	Duplex Receptacle (Not provided)	Tape Measure	Electric Drill

IMPORTANT SAFETY INSTRUCTIONS - SAVE THESE INSTRUCTIONS

Read all instructions before using this mirror.

DANGER - To reduce the risk of electric shock; Always unplug this mirror from the electrical outlet before cleaning.

WARNING - To reduce the risk of burns, fire, electric shock, or injury to persons:

- Unplug from outlet before putting on or taking off parts.
- Close supervision is necessary when this mirror is used by, or near children, invalids, or disabled persons.
- Use this mirror only for its intended use as described in these instructions. Do not use attachments not recommended by elio (ITC Inc).
- Never operate this mirror if it has a damaged cord or plug, if it is not working properly, if it has been dropped or damaged, or dropped into water. Contact elio for a replacement mirror.
- Keep the cord away from heated surfaces.
- Never drop or insert any object into any opening.
- Do not use outdoors.
- **WARNING:** Risk of electric shock - Connect this mirror to a properly grounded outlet only. See grounding instructions.

GROUNDING INSTRUCTIONS

This mirror is for use on a nominal 120V circuit and has a three prong grounding plug that looks like the plug illustrated in sketch below. Make sure that the mirror is connected to an outlet having the same configuration as the plug. No adapter should be used with this mirror.

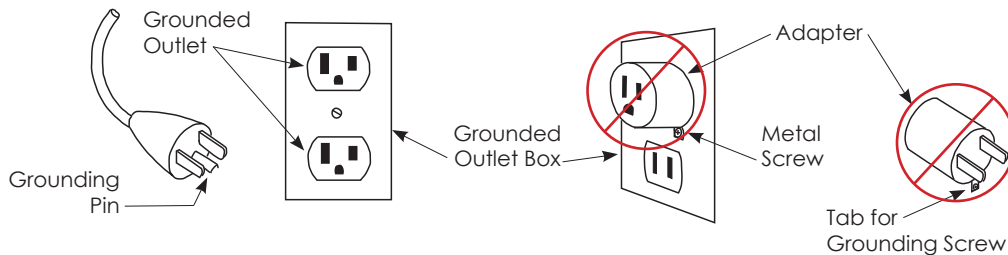

1. Mark the location of the wire exit and mounting holes. See individual product specifications for mounting hole locations.

Install a duplex receptacle (not provided).

The mirror has a 30" cord with three-prong plug, so the outlet should be installed a few inches away from the wire exit. Locating it too close to the wire exit may interfere with the power supply housing and prevent the mirror from being plugged in properly.

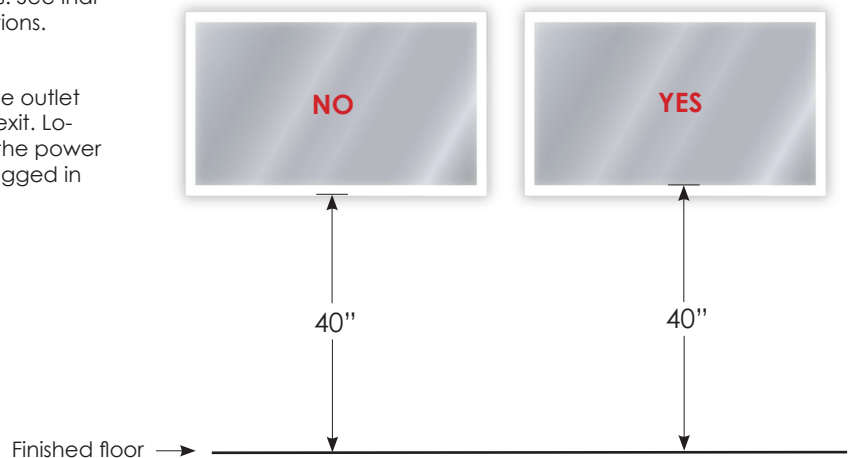

ADA requires that "Mirrors shall be mounted with the bottom edge of the reflecting surface no higher than 40 in (1015mm) above the finished floor¹." For lit mirrors this means the dimension is to the inner most edge of the lit portion.

¹ - 2010 ADA Standards 603.3 <https://www.ada.gov>

2. Install #14 round slotted wood mounting screws into pre-marked holes. Note, all mirrors must be installed in contractor supplied blocking.
Plug in the mirror and test light to ensure all connections work.
Slide the mirror onto the screws.

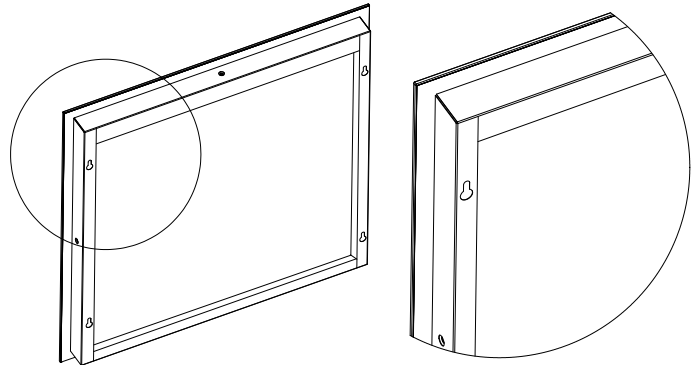

3. TROUBLESHOOTING

The mirror doesn't light:

- A. Check the connection between the mirror and buildings wiring.
- B. Verify that there is power coming out of the power supply.
- C. Verify that there is 120V power coming out of the buildings junction box.
- D. Verify that the tape light has not been unplugged from the power supply.

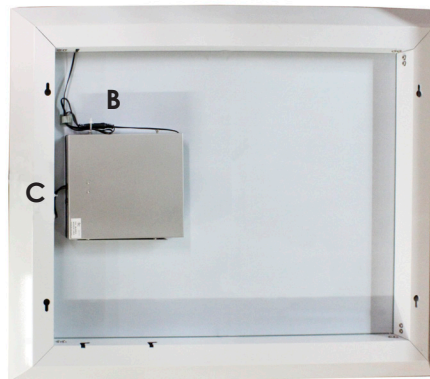

Part of the mirror won't light:

- E. This is mostly likely due to a bad LED, however, follow the previous steps to make sure all connections are done correctly.

The lighting looks discolored:

- F. This can be caused by dust settling in the mirror on the tape light. The dust can be cleaned off using an electronic's spray cleaner.

